

Leksell Stereotactic System®

Overview

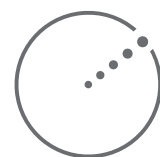

*The world's most trusted
stereotactic system*



ELEKTA

Right on Target

The highest level of clinical accuracy

Leksell Stereotactic System® provides tools that support a unique level of clinical accuracy, while reducing the amount of planning and treatment time. And for the patient, that accuracy can shorten the length of stay in hospital and the process of rehabilitation.

With more than 1,500 sites around the world, Leksell Stereotactic System is the benchmark solution in stereotactic neurosurgery. The superior clinical accuracy of the system's frame-based approach translates directly into greater value for all concerned. It enables shorter planning times, broader procedural possibilities, optimal outcomes and faster patient recovery rates. The simple, effective design of the frame provides the versatility for a wide range of applications for diagnostic, therapeutic, functional and minimally invasive procedures.

Leksell Stereotactic System is the system of choice for training and education at most academic institutions. To date, the results of treatment with Leksell Stereotactic System are documented in over 1,000 clinical papers.

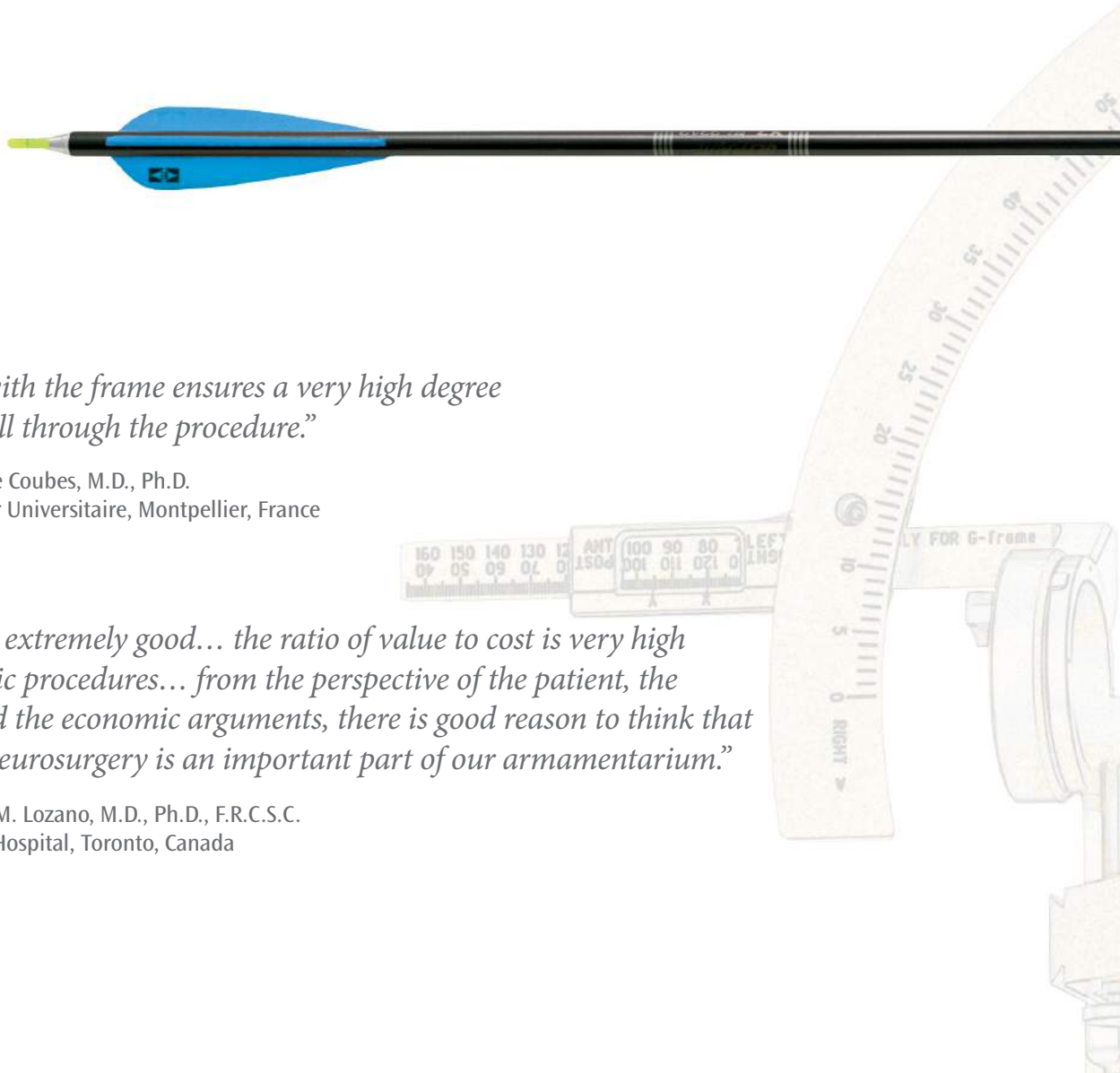

“Operating with the frame ensures a very high degree of accuracy all through the procedure.”

Professor Philippe Coubes, M.D., Ph.D.
Centre Hospitalier Universitaire, Montpellier, France

“The value is extremely good... the ratio of value to cost is very high for stereotactic procedures... from the perspective of the patient, the outcomes and the economic arguments, there is good reason to think that stereotactic neurosurgery is an important part of our armamentarium.”

Professor Andres M. Lozano, M.D., Ph.D., F.R.C.S.C.
Toronto Western Hospital, Toronto, Canada



Why Leksell Stereotactic System?

- The benchmark solution with over 1,500 sites

- Accurate and dedicated instruments

- Designed by neurosurgeons, for neurosurgeons

- One integrated system

- Versatile – wide range of applications

Applications

A wide range of options

The hallmarks of Elekta's system for stereotactic neurosurgery are simplicity, versatility and accuracy; and all accessories are easy to learn and easy to use. Described here are some of the most frequently used current applications.

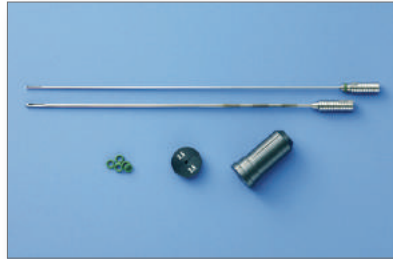

Biopsies

Leksell Stereotactic System® provides the neurosurgeon with a wide variety of biopsy instrumentation for any type of tumor and different preferred techniques.



Catheter Insertions

Abscess drainage can be done with the Backlund Catheter Insertion Needle Kit, as well as challenging ventricular shunting or drainage.



Gamma Knife® Surgery

Leksell® Coordinate Frame is fully compatible with all Leksell Gamma Knife® systems, ensuring the highest possible accuracy.



Injections and Aspirations

A selection of needles for injecting radioactive nuclides and cytostatic agents, as well as puncture of cysts.

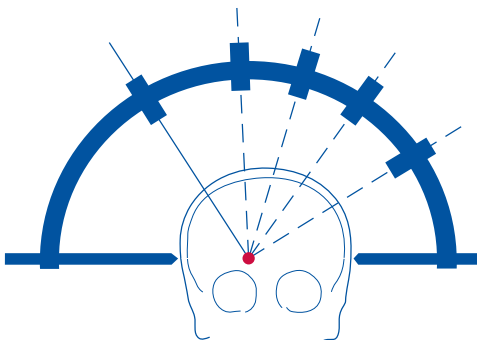

Center-of-arc: The Proven Principle

Leksell Stereotactic System is based on the proven center-of-arc principle. The basic components are the Leksell Coordinate Frame and the Leksell Multi Purpose Stereotactic Arc. This allows full flexibility in terms of access to all intracranial areas and provides complete freedom of choice in trajectory and entry point selection.

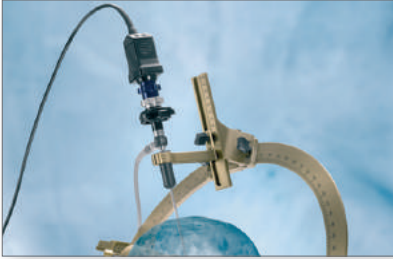

Endoscope Guidance

Leksell® Endoscope Adapter stereotactically guides the endoscope for reaching deep targets with the highest accuracy while also minimizing trauma.



Electrode Positioning

The fully integrated Elekta MicroDrive™ provides the utmost accuracy and confidence when positioning electrodes for Micro Electrode Recording (MER), macro stimulation and Deep Brain Stimulation (DBS) electrode implantation.

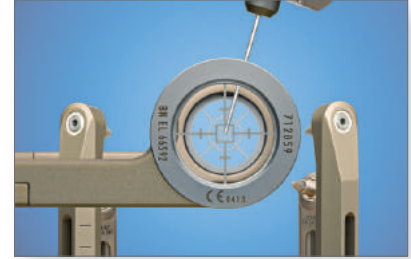

Implantations

A variety of instruments are available for catheter insertion and DBS electrode implantation. They are supported by Cross-Hairs and A-P holder to verify position.



Brain Lesioning

The wide range of brain lesion electrodes is fully integrated with Leksell Stereotactic System enabling precise target precision and the most optimized lesioning.

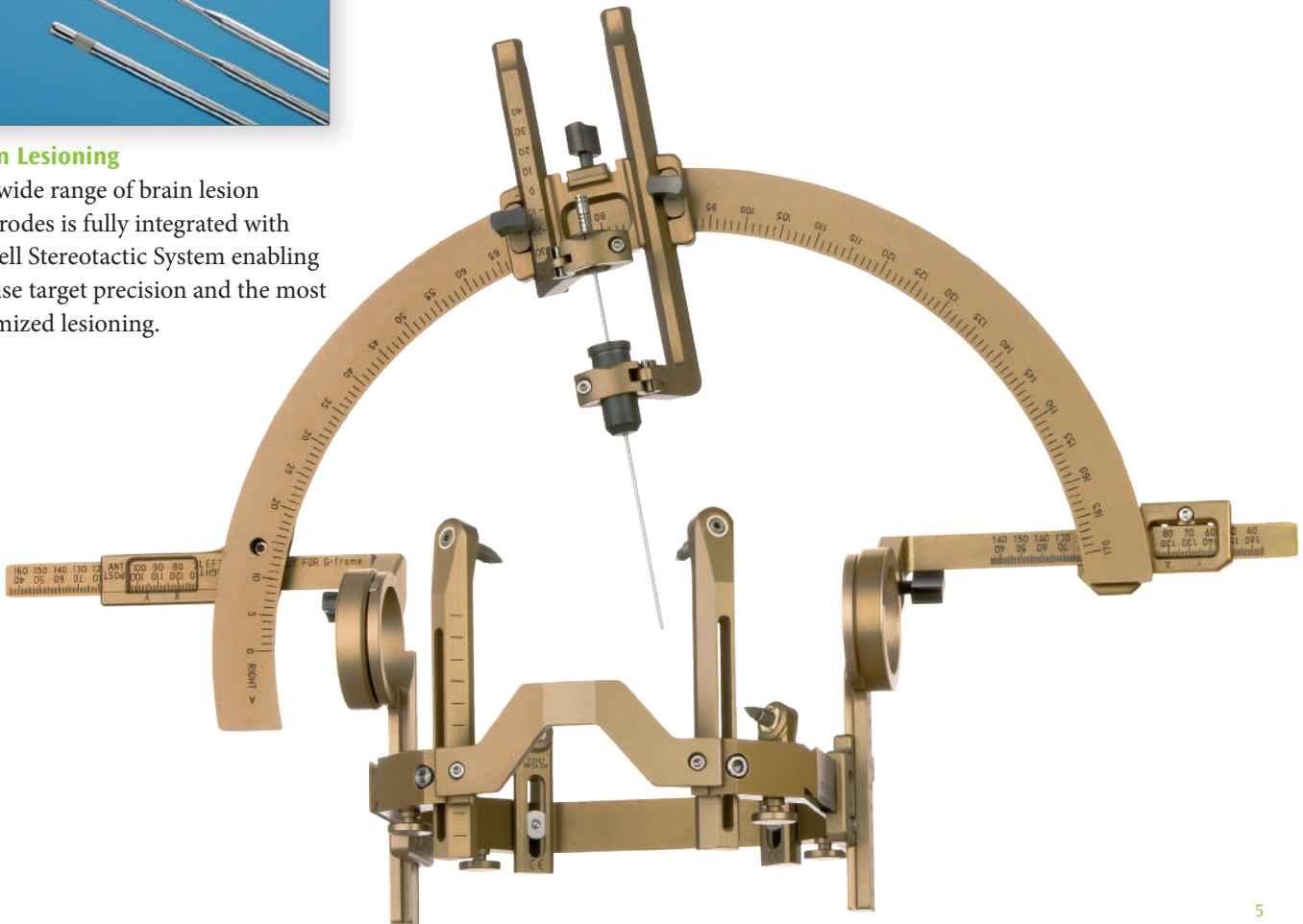

Fixation and Imaging

Seeing the whole picture

Leksell Stereotactic System® has been continuously developed to support the need for fast, clinically accurate diagnosis and new imaging techniques. Using the Leksell® Coordinate Frame as a simple, reliable base, the patient is ready for any form of scanning technique. Target localization and coordinate determination are quick and simple, offering a choice of independent localization methods.

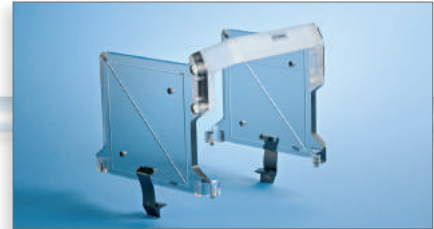
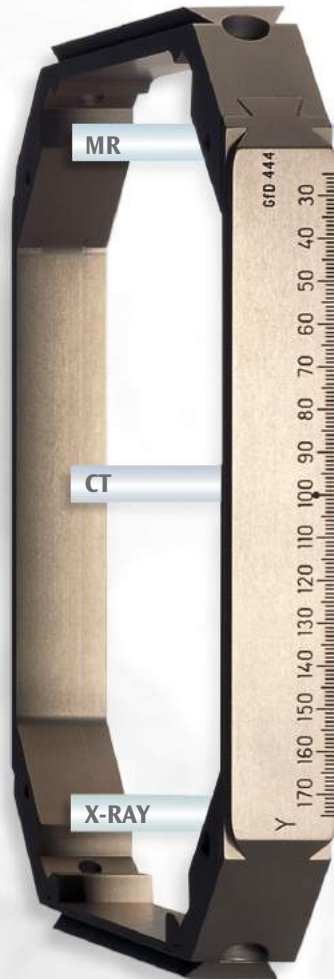

Attaching the Frame – Four Screws, That's It

The frame is fixed to the patient's head with adjustable fixation posts and just four small, self-tapping screws. Only local anesthesia is needed and preparation time is kept to a minimum for maximum patient comfort. Imaging can take place once the frame is attached.

The frame serves as the base for all subsequent steps of the stereotactic procedure – no additional components need to be added to the patient's skull.

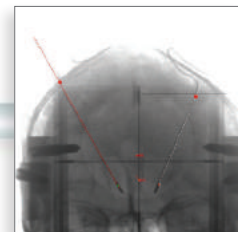
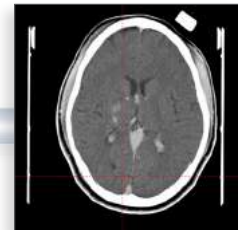
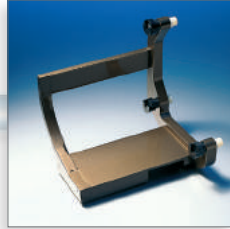

Accurate Scanning Made Easy

Leksell Stereotactic System[®] is compatible with numerous imaging modalities. MR, CT and Angio can be performed in any sequence without changing the frame or moving its position.

The different indicator boxes generate the fiducial marks during scanning. They are customized for each kind of imaging modality and are easy to use. The boxes are snapped onto the coordinate frame, designed to fit into tight head coils and provide high patient comfort.

A frame adapter secures and supports the patient's head in place of the standard headrest during scanning. This ensures parallel equidistant images for easier pre-operative planning procedures and comparison with stereotactic atlases. Adapters are available for most scanners. In preventing movement distortion, they further guarantee the quality and accuracy of the neurosurgical procedure.

Target Determination

Planning for better outcomes

The ability to plan with greater ease and accuracy increase the chance of a successful outcome. The powerful PC-based Linux operating system and flexible pre-planning capabilities of Leksell SurgiPlan® offers neurosurgeons more freedom to plan efficiently and evaluate different surgical approaches.

Going Places

The modular design of Leksell SurgiPlan ensures that as demands grow, they can always be met in a focused, cost-effective manner. Adding to its flexibility, Leksell SurgiPlan is also available on a dedicated, high-end PC laptop for use anytime, anywhere.

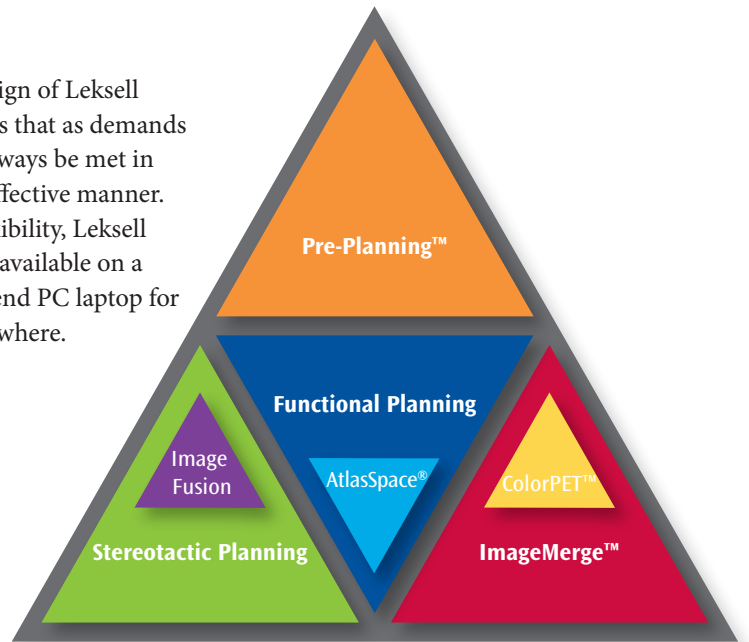

Leksell SurgiPlan Clarifies the Target

This advanced, modular neurosurgical planning software is specifically designed for use with the Leksell Stereotactic System®. Targets and surgical paths can be outlined and manipulated across different image views with immediate visual feedback during stereotactic planning.

Based on a reliable, high-performance operating system, advanced image handling options are combined with a graphic interface for ease-of-use. Image studies can be aligned to the AC-PC line for easier interpretation and comparison with stereotactic atlases. Targets can be localized using the AC-PC line-based formulas that generate the corresponding stereotactic coordinates.

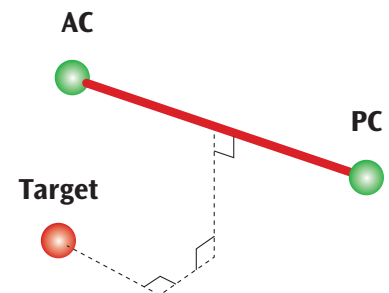
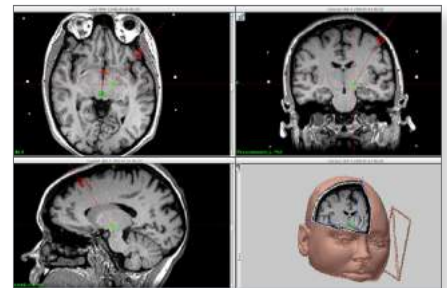

AtlasSpace for Confident Navigation

AtlasSpace® is based on the original Schaltenbrand & Wahren¹ atlas, providing sophisticated 3-D matching, overlay of atlas contours on patient images and interactive selection of displayed atlas contours. It aids confidence and ease-of-use by facilitating interpretation and identification of correct targets.

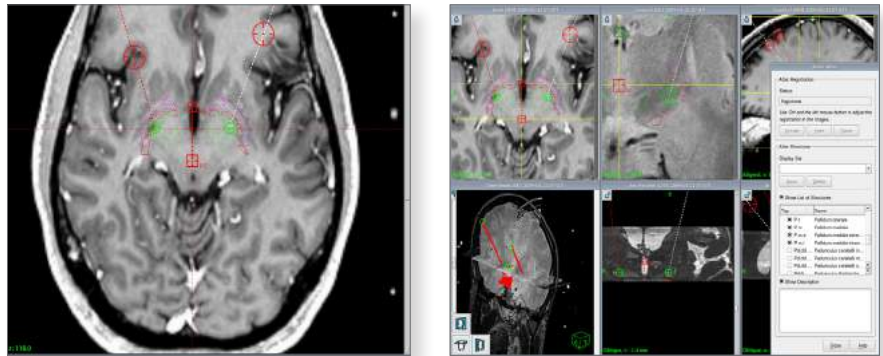

Pre-Planning Saves Time, Extends Options

Pre-Planning™ allows the neurosurgeon to plan surgical procedures days ahead of the surgery using frameless images, which can save time and resources. All that is needed on the day of the surgery is a CT or MR registration scan with the stereotactic frame. The plan can then be imported and co-registered using ImageMerge™. Once created in the plan, the entire treatment is transformed into Leksell® coordinates.

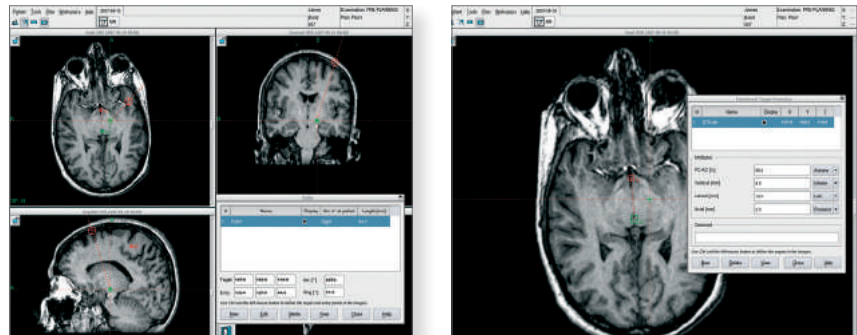

ImageMerge Streamlines Procedures

ImageMerge streamlines the procedure of image interpretation and pre-operative planning through the co-registration of both frame-based and frameless images. ImageMerge can also be used for follow-up by aligning post-operative images with image studies used at surgery. It allows for better interpretation by combining different image modalities such as CT, MR and PET.

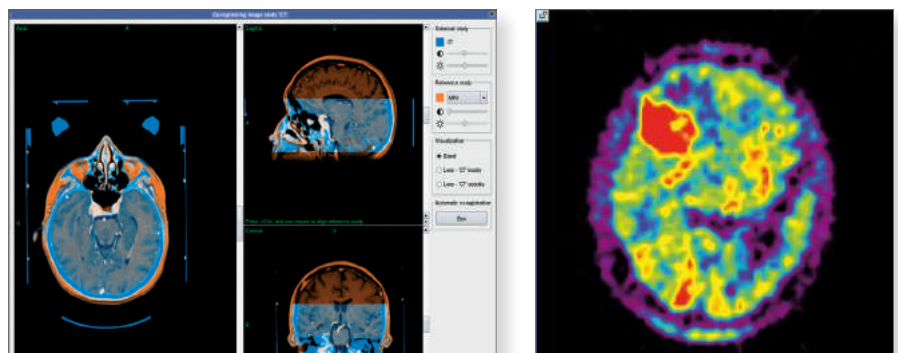

1. © George Thieme Verlag, Stuttgart/New York

Treatment

Leksell® Neuro Generator

Leksell Stereotactic System® remains the benchmark for clinical accuracy, efficiency and versatility today.

Together with Leksell® Neuro Generator it serves as the foundation in the continuous quest to optimize solutions. These procedures include macro stimulation and injection of stem cells, growth hormones or drugs. In addition, Leksell Stereotactic System offers tools for facilitating DBS electrode implantation.

First Choice for the Task

Leksell Neuro Generator is a complete system designed for a wide range of treatment techniques and therapies, including:

- Impedance measurement
- Macro stimulation
- Continuous RF treatment
- Pulsed RF treatment
- Stereotactic brain lesioning
- Bipolar coagulation

The Active Tissue Characterization feature further helps in the delicate performance of procedures by automatically testing specific tissue response to small amounts of current before each treatment. It will then optimize parameters accordingly, enabling safer treatment and a better outcome for the patient.

Easy to Understand, Easy to Use

Leksell Neuro Generator is characterized by its easy-to-use graphical user interface, compact size and remotely controlled features, allowing the practitioner to work closer to the patient. It can also be safely and effectively operated while draped under full sterility conditions.





45V

LESION PULSED RF

Impedance, Stimulation and Lesioning

Brain Lesion Electrodes

Fast Macro Stimulation, Accurate Lesioning

Brain Lesion Electrodes can be used with Leksell® Neuro Generator and Leksell Stereotactic System® when performing macro stimulation, impedance measurement and lesioning. They are suitable for both target verification and lesioning. Target verification is performed when patient active response is required during procedures.

The electrodes are available in monopolar, dual monopolar and bipolar versions, all with various diameters. All electrodes have integrated thermocouple controlled temperature sensing and are fully autoclavable.



Elekta MicroDrive Bipolar MacroElectrode

Easier DBS Electrode Implantation

Elekta MicroDrive™ Bipolar MacroElectrode is intended for target verification and lesioning. Target verification is achieved using macro stimulation and impedance measurement.

The electrode is designed to be used with Elekta MicroDrive, Leksell Neuro Generator and Leksell Stereotactic System. It is especially suited for macro stimulation to accurately find the correct target for DBS electrode implantation, using Elekta MicroDrive and its unique, specially designed parts for DBS electrode implantation.

The electrode also brings the accuracy of Elekta MicroDrive to find the optimal position when lesioning is the preferred method. Elekta MicroDrive Bipolar MacroElectrode has an integrated thermo-couple control and is fully autoclavable.



Fine electrodes for continuous and pulsed RF treatment

All of these electrodes have been specifically designed for use with Leksell® Neuro Generator. They have an integrated thermocouple element at the very tip to ensure correct temperature monitoring during the procedure.



The same electrode can be used for stimulation, impedance monitoring and for temperature controlled lesioning.

The electrodes and cannulas are available in a wide range of combinations for different applications. Elekta offers both straight and curved cannulas, with sharp or blunt tip and a diversity of tip lengths.



Electrode Positioning

Elekta MicroDrive™

Confident, Accurate Localization

Elekta MicroDrive™ is designed to find the optimal electrode position with the utmost accuracy. This makes it invaluable when performing MER, macro stimulation and DBS electrode implantation.

It offers considerable freedom to the neurosurgeon by supporting different localization methods, and will allow simultaneous recording of up to five electrodes.

DBS implantation is supported by dedicated and integrated components that ensure simplified and correct placement.

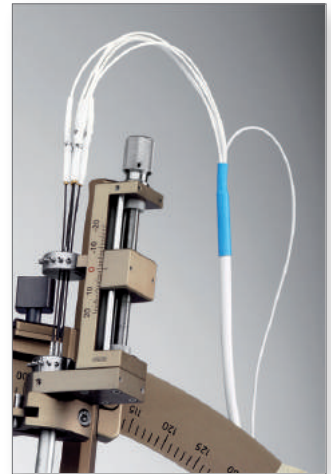
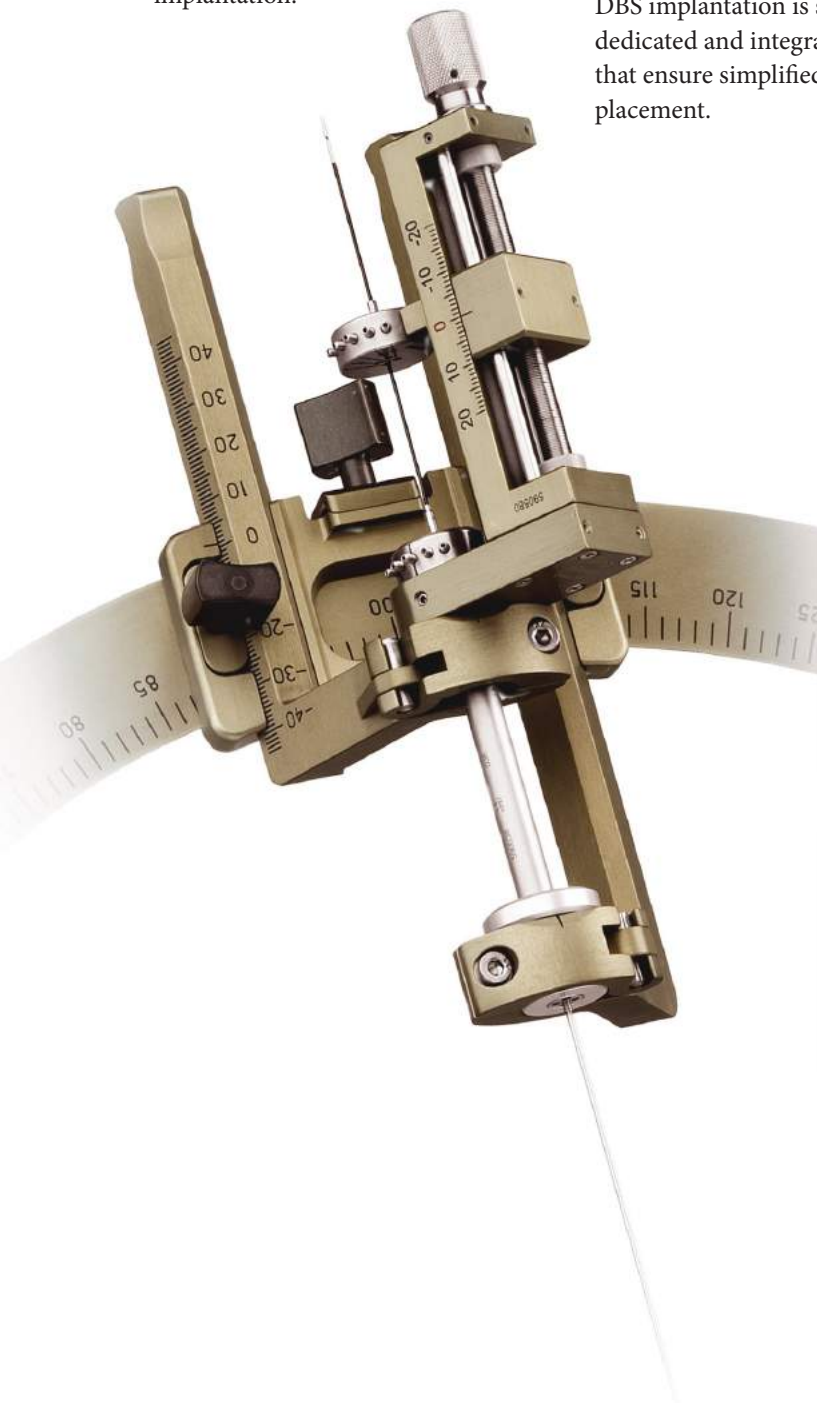

Biopsy

The first choice for biopsies

The accuracy and flexibility of Leksell Stereotactic System® makes it the first choice for fast and cost-efficient biopsies. Supported by a range of instruments for different biopsy techniques, it is the least invasive and most versatile solution, particularly for deep-seated and awkwardly positioned tumors.

All biopsy kits are reusable after sterilization procedure except for the Disposable Biopsy Needle Kit. This kit is a complete solution of new disposable components which addresses the growing issues of persistent cross-contamination.

Frame-based biopsies are effective in providing tissue diagnosis with a minimum of complications. They are also proven to require less anesthetic resources, less operating room time and shorter hospitalization time for patients, when compared with image-guided systems.

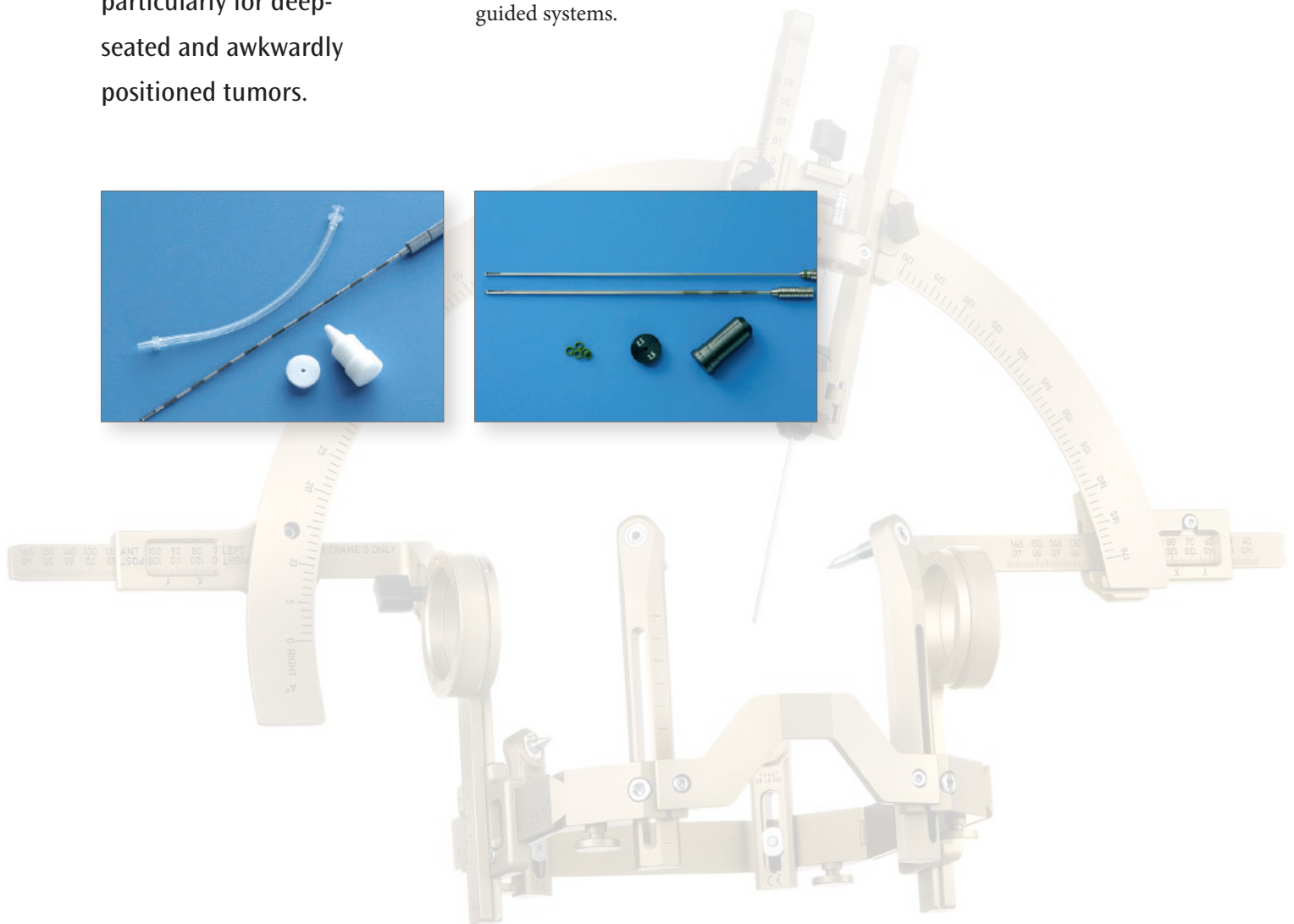

Quality Assurance

Surgical confidence through assured accuracy

Dedicated quality assurance tools ensure the optimum accuracy of Leksell Stereotactic System® and its accessories to enable the best possible clinical outcomes.

Target Simulator Provides Instant Accuracy Check

The unique Target Simulator further enhances confidence in the accuracy of Leksell Stereotactic System by providing a simple but reliable means of testing the total accuracy of the stereotactic frame and arc. The solid test targets represent commonly used targets in the brain, as well as extreme positions.

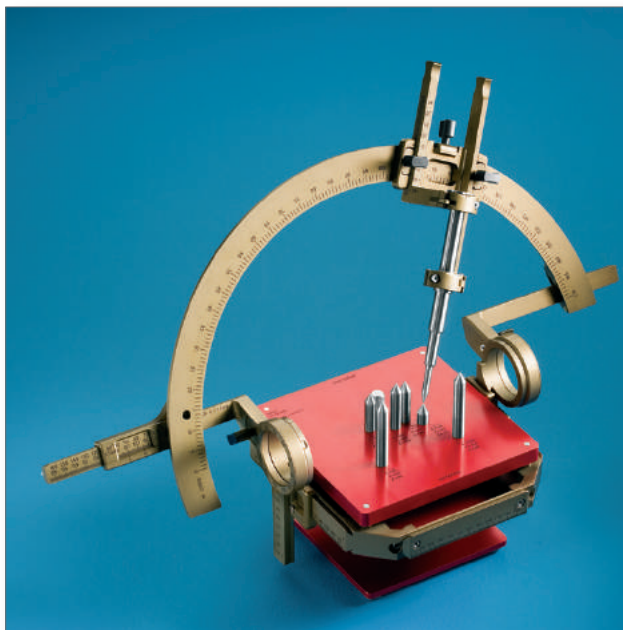

Needle Tester

This dedicated tool is designed to assure the straightness of needles and thus their fitness of purpose for performing surgery with Leksell Stereotactic System. The tool quickly indicates the smallest deviations from true straightness.



Service and Support



Guaranteed accuracy for life

Elekta Services is more than a service and support program. It is Elekta's commitment to optimizing the entire continuum of care by improving clinical effectiveness, ensuring staff competence and smoothing patient flow. Above all, it is about maximizing the investment in stereotactic neurosurgery.

A range of service and support programs are available for Leksell Stereotactic System®, Leksell SurgiPlan® and Leksell® Neuro Generator, which provide the clinic with guaranteed assurance of the accuracy of their equipment throughout the lifetime of the system.

Ensuring Staff Competence

Staff competence and familiarity with the principles of stereotaxy are critical in gaining maximum advantage of the system's accuracy. Elekta Services offers a wide range of education and application training courses from basic to advanced stereotactic neurosurgery.



Workflow

Accuracy in every step

In continuous daily use in medical facilities around the world, the frame-based stereotactic system demonstrates significant advantages over other fixation solutions. Accuracy, ease-of-use and excellent reliability are three key attributes of Leksell Stereotactic System®, and the advantages also include less anesthetic resources, less operating time and shorter hospital stays.

The patient treatment can be performed according to two different workflows – either by using Pre-Planning™ or not.

By using the pre-planning option the neurosurgeon achieves greater flexibility and more efficient scheduling. Alternatively, to plan on the day of surgery gives a more straightforward procedure with fewer steps.

► Imaging

When using Pre-Planning, imaging is performed without the patient carrying the Leksell® Coordinate Frame. The frameless images can derive from CT, MR or PET scanning.

In the other, optional workflow the coordinate frame is used and a frame-based scan is made. The coordinate frame adapter ensures parallel equidistant images and prevents movement distortion during scanning.

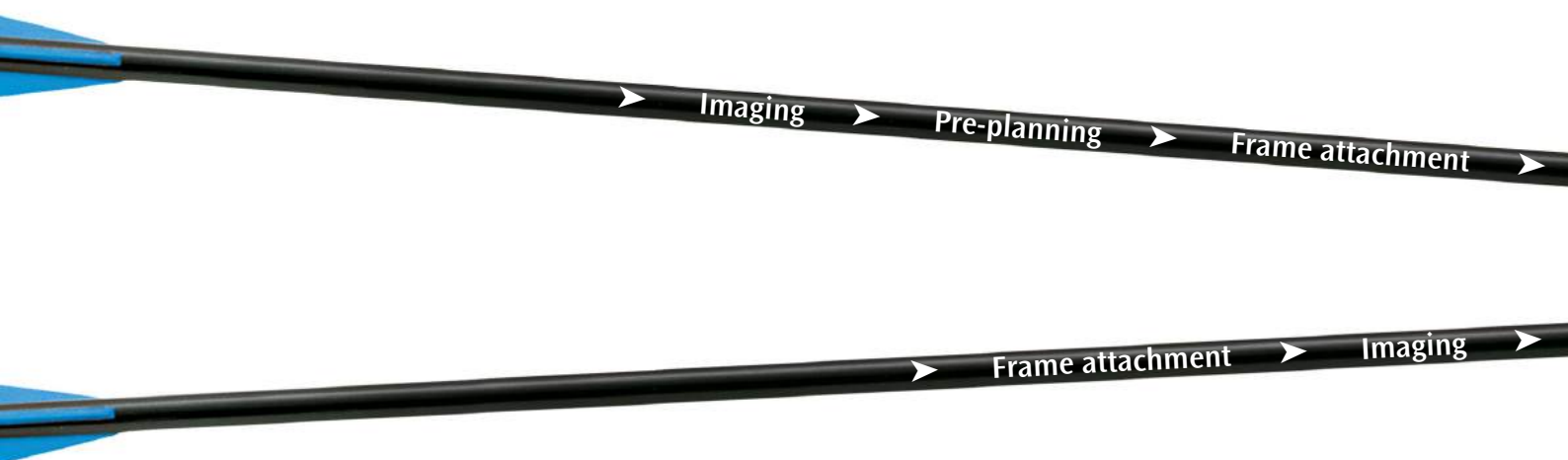

► Pre-planning

By using the Pre-Planning™ module in Leksell SurgiPlan®, imaging and surgical planning can be done prior to the day of surgery. Pre-planning increases freedom of choice for the neurosurgeon and enables efficient scheduling. Target localization and path planning are performed on the image studies taken without the frame, and temporary target coordinates are generated.

The powerful functionality of the PC-based Leksell SurgiPlan eases the workload in identifying the target, and planning and evaluating different surgical approaches.

► Frame Attachment

Fixation of the coordinate frame to the patient's head is achieved with adjustable fixation posts and four self-tapping screws. A variety of exchangeable front pieces and fixation posts allows maximum flexibility in terms of positioning and patient comfort. The coordinate frame can be fixed in an angled position for optimal access to the selected target.

► Target Determination

Elekta simplifies the whole process of target localizing and determining target coordinates with a choice of accurate calculation systems to suit the neurosurgeon's preference. Systems range from manual methods or use of the scanner's console, to Elekta's sophisticated PC-based planning system, Leksell SurgiPlan. The powerful functionality of this advanced planning software eases the workload in identifying the target, and planning and evaluating different surgical approaches.

“It uses a simple and intuitive frame that is accurate, reliable and is well tolerated by patients.”

Ali R. Rezai, M.D.

Professor of Neurological Surgery;

Director, Center for Neuromodulation

The Ohio State University Medical Center, Columbus, Ohio, U.S.A.



► Registration

This step consists of scanning and co-registration. With the coordinate frame in position, a frame-based CT or MR scan is made. The coordinate frame adapter ensures parallel equidistant images and prevents movement distortion during scanning.

The frame-based image studies are co-registered with the previously taken frame-less images used for pre-planning and the correct Leksell® coordinates are generated.

► Coordinate Setting

Once planning is complete, the system is prepared for surgery by attaching the stereotactic arc to the coordinate frame. The stereotactic arc is positioned according to the X, Y and Z coordinates determined for the target so that the center-of-arc coincides with the selected cerebral target. The planned trajectory is then set by simply dialing in the determined arc and ring angles.

If the target has been manually determined it can be reached along any trajectory since the system is based on the center-of-arc principle.

► Treatment

The coordinate frame and the stereotactic arc provide a stable and reliable treatment platform with proven sub-millimeter accuracy. Procedures usually require minimal preparation and operating time, while the small burr hole reduces the level of trauma. A wide range of fully integrated instruments such as Elekta MicroDrive™ and biopsy instrumentation help maximize the efficiency and accuracy of procedures. The instrument guide on the arc ensures stable, accurate positioning of instruments close to the skull.

“From a practical point of view, you can’t get more accuracy than in frame-based stereotaxy...”

“...when using the frame you superimpose the Cartesian coordinate system on the brain and can be in control. When using a ‘frameless’ system you’re not in direct control yourself – that’s the main difference...”

Dr PR Schuurman, M.D., Ph.D.
Academic Medical Center, University of Amsterdam, the Netherlands

Elekta's system within stereotactic neurosurgery is intended to support and fulfill each physician's desire to excel. To do this, we provide a cost-efficient and superior system that improves both the quality of treatment and ultimately the quality of life for patients. The Leksell Stereotactic System® achieves this by ensuring the highest accuracy during every step of the treatment.



A human care company, Elekta pioneers significant innovations and clinical solutions for treating cancer and brain disorders. Elekta provides intelligent and resource-efficient technologies that improve, prolong and save patient lives. We go beyond collaboration seeking long-term relationships built on trust with a shared vision, offering confidence to healthcare providers and their patients.

*The products in this brochure may not be cleared for sales in all markets.
Please contact your Elekta sales representative for more information.*

www.elekta.com

Human Care Makes the Future Possible

Corporate Head Office:

Elekta AB (publ)
Box 7593, SE-103 93 Stockholm, Sweden
Tel +46 8 587 254 00
Fax +46 8 587 255 00
info@elekta.com

Regional Sales, Marketing and Service:

North America

Tel +1 770 300 9725
Fax +1 770 448 6338
info.america@elekta.com

**Europe, Middle East, Africa,
Eastern Europe, Latin America**

Tel +46 8 587 254 00
Fax +46 8 587 255 00
info.europe@elekta.com

Asia Pacific

Tel +852 2891 2208
Fax +852 2575 7133
info.asia@elekta.com

